

**brother**

# Operation Manual

## Sewing Machine

Product Code: 888-X64/X74/X84/X67/X77/X87

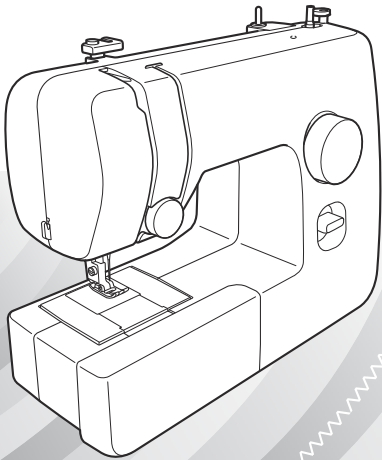

Be sure to read this document before using the machine.  
We recommend that you keep this document nearby for future reference.

# IMPORTANT SAFETY INSTRUCTIONS

Please read these safety instructions before attempting to use the machine.

## **⚠ DANGER**

- To reduce the risk of electric shock:

**1** Always unplug the machine from the electrical outlet immediately after using, when cleaning, when making any user servicing adjustments mentioned in this manual, or if you are leaving the machine unattended.

## **⚠ WARNING**

- To reduce the risk of burns, fire, electric shock, or injury to persons.

**2** Always unplug the machine from the electrical outlet when making any adjustments mentioned in the instruction manual:

- To unplug the machine, switch the machine to the symbol "O" position to turn it off, then grasp the plug and pull it out of the electrical outlet. Do not pull on the cord.
- Plug the machine directly into the electrical outlet. Do not use an extension cord.
- Always unplug your machine if the power is cut.

**3** Electrical Hazards:

- This machine should be connected to an AC power source within the range indicated on the rating label. Do not connect it to a DC power source or inverter. If you are not sure what kind of power source you have, contact a qualified electrician.
- This machine is approved for use in the country of purchase only.

**4** Never operate this machine if it has a damaged cord or plug, if it is not working properly, if it has been dropped or damaged, or water is spilled on the unit. Return the machine to the nearest authorized Brother dealer or service center for examination, repair, electrical or mechanical adjustment.

- While the machine is stored or in use if you notice anything unusual, such as an odor, heat, discoloration or deformation, stop using the machine and immediately unplug the power cord.
- When transporting the machine, be sure to carry it by its handle. Lifting the machine by any other part may damage the machine or result in the machine falling, which could cause injuries.
- When lifting the machine, be careful not to make any sudden or careless movements, otherwise you may injure your back or knees.

**5** Always keep your work area clear:

- Never operate the machine with any air openings blocked. Keep ventilation openings of the machine and foot control free from the build up of lint, dust, and loose cloth.
- Do not store objects on the foot controller.
- Do not use extension cords. Plug the machine directly into the electrical outlet.
- Never drop or insert any object into any opening.
- Do not operate where aerosol (spray) products are being used or where oxygen is being administered.

- Do not use the machine near a heat source, such as a stove or iron; otherwise, the machine, power cord or garment being sewn may ignite, resulting in fire or an electric shock.
- Do not place this machine on an unstable surface, such as an unsteady or slanted table, otherwise the machine may fall, resulting in injuries.

## 6 Special care is required when sewing:

- Always pay close attention to the needle. Do not use bent or damaged needles.
- Keep fingers away from all moving parts. Special care is required around the machine needle.
- Do not turn on the machine while pressing down the foot controller. The machine may start unexpectedly and cause personal injury or damage to the machine.
- Switch the machine to the symbol “O” position to turn it off when making any adjustments in the needle area.
- Do not use a damaged or incorrect needle plate, as it could cause the needle to break.
- Do not push or pull the fabric when sewing, and follow careful instruction when freehand stitching so that you do not deflect the needle and cause it to break.

## 7 This machine is not a toy:

- Your close attention is necessary when the machine is used by or near children.
- The plastic bag that this machine was supplied in should be kept out of the reach of children or disposed of. Never allow children to play with the bag due to the danger of suffocation.
- Do not use outdoors.

## 8 For a longer service life:

- When storing this machine, avoid direct sunlight and high humidity locations. Do not use or store the machine near a space heater, iron, halogen lamp, or other hot objects.
- Use only neutral soaps or detergents to clean the case. Benzene, thinner, and scouring powders can damage the case and machine, and should never be used.
- Always consult the operation manual when replacing or installing any assemblies, the presser feet, needle, or other parts to assure correct installation.

## 9 For repair or adjustment:

- If the light unit (light-emitting diode) is damaged, it must be replaced by authorized Brother Service Center.
- In the event a malfunction occurs or adjustment is required, first follow the troubleshooting table in the back of the operation manual to inspect and adjust the machine yourself. If the problem persists, please consult your local authorized Brother Service Center.

**Use this machine only for its intended use as described in this manual.**

**Use accessories recommended by the manufacturer as contained in this manual.**

**The contents of this manual and specifications of this product are subject to change without notice.**

**For additional product information, visit our web site at [www.brother.com](http://www.brother.com)**

# SAVE THESE INSTRUCTIONS

**This machine is intended for household use.**

## **FOR USERS IN COUNTRIES EXCEPT EUROPEAN COUNTRIES**

This appliance is not intended for use by persons (including children) with reduced physical, sensory or mental capabilities, or lack of experience and knowledge, unless they have been given supervision or instruction concerning use of the appliance by a person responsible for their safety. Children should be supervised to ensure that they do not play with the appliance.

## **FOR USERS IN EUROPEAN COUNTRIES**

This appliance can be used by children aged from 8 years and above and persons with reduced physical, sensory or mental capabilities or lack of experience and knowledge if they have been given supervision or instruction concerning use of the appliance in a safe way and understand the hazards involved. Children shall not play with the appliance. Cleaning and user maintenance shall not be made by children without supervision.

## **FOR USERS IN THE UK, EIRE, MALTA AND CYPRUS ONLY**

### **IMPORTANT**

- In the event of replacing the plug fuse, use a fuse approved by ASTA to BS 1362, i.e. carrying the  mark, rating as marked on plug.
- Always replace the fuse cover. Never use plugs with the fuse cover omitted.
- If the available electrical outlet is not suitable for the plug supplied with this equipment, you should contact your authorized Brother Service Center to obtain the correct lead.

# CONTENTS

## IMPORTANT SAFETY INSTRUCTIONS ..... 1

## 1. KNOWING YOUR SEWING MACHINE ..... 5

### ACCESSORIES ..... 5

Optional accessories ..... 5

### THE MAIN PARTS ..... 6

Flat bed attachment ..... 6

### USING YOUR SEWING MACHINE ..... 7

Connecting plugs ..... 7

Main power and sewing light switch ..... 8

Foot controller ..... 8

Checking the needle ..... 8

Replacing the needle ..... 8

Changing the presser foot ..... 10

### THE CONTROLS ..... 11

Pattern selection dial ..... 11

Patterns and stitch names ..... 11

Reverse sewing lever ..... 12

### THREADING THE MACHINE ..... 13

Winding the bobbin ..... 13

Lower threading ..... 15

Lower threading (for models equipped with a quick-set bobbin) ..... 16

Upper threading ..... 17

Using the needle threader (for models equipped with a needle threader) ..... 19

Drawing up the lower thread ..... 21

### FABRIC, THREAD, AND NEEDLE

### COMBINATIONS ..... 22

## 2. SEWING BASICS ..... 23

Please read before sewing ..... 23

Starting sewing ..... 23

Trial sewing ..... 24

Changing the sewing direction ..... 24

Sewing thick fabrics ..... 24

Sewing thin fabrics ..... 25

Sewing stretch fabrics ..... 25

Stitching cylindrical pieces ..... 25

Sewing with a twin needle (Option) ..... 25

Thread tension ..... 27

## 3. BUILT-IN STITCHES ..... 29

Straight stitching ..... 29

Zigzag stitching ..... 29

Blind hem stitching ..... 30

Overedge stitching ..... 31

Elastic stitching ..... 31

Double action stitching ..... 32

## 4. SEWING BUTTONHOLES ..... 33

Making a buttonhole ..... 33

Adjusting buttonholes ..... 34

## 5. USING ATTACHMENTS AND APPLICATIONS ..... 35

Zipper insertion ..... 35

Gathering ..... 36

Appliqués ..... 36

### USING OPTIONAL ACCESSORIES ..... 37

Sewing buttons ..... 37

Darning ..... 38

Using the blind stitch foot ..... 39

## 6. APPENDIX ..... 40

### MAINTENANCE ..... 40

Restrictions on oiling ..... 40

Precautions on storing the machine ..... 40

Cleaning ..... 40

### TROUBLESHOOTING ..... 42

### INDEX ..... 45

# 1 KNOWING YOUR SEWING MACHINE

## ACCESSORIES

We have designed these accessories to help you easily perform most sewing tasks.

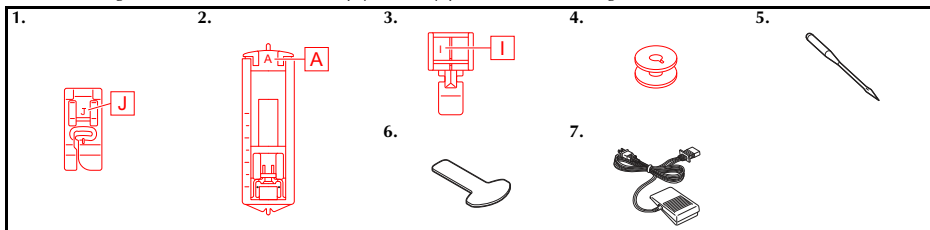

No.	Part Name	Part Code	
		Americas	Others
1	Zigzag foot "J" (on machine)	XC4901-121	
2	Buttonhole foot "A"	X59369-321	
3	Zipper foot "I"	XE9369-001	
4	Bobbin (One is on machine)	SA156	SFB: XA539-151

No.	Part Name	Part Code	
		Americas	Others
5	Needle set (90/14 needle)	3-piece set: XE5328-001 2-piece set: XE7064-001	
6	Screwdriver	XF3557-001	
7	Foot controller	See page 6	



### Note

- The included accessories vary depending on the machine model.

## Optional accessories

The following are available as optional accessories to be purchased separately. Depending on the model you purchased, the following accessory may be included with your machine.

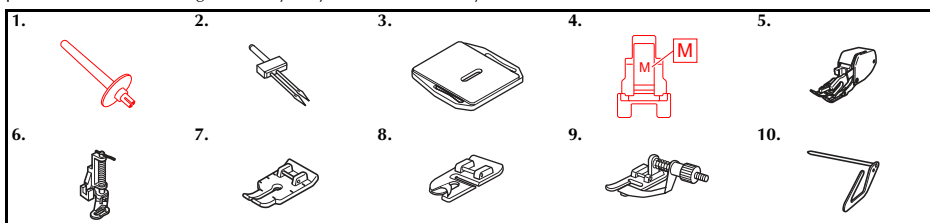

No.	Part Name	Part Code	
		Americas	Others
1	Extra spool pin	XG3488-001	
2	Twin needle (2.0/75 needle)	X57521-021	
3	Darning Plate	XC6063-021	
4	Button sewing foot "M"	XE2137-001	
5	Walking Foot	SA107	F034N: XC2165-002
6	Quilting Foot	SA129	F005N: XC1948-052

No.	Part Name	Part Code	
		Americas	Others
7	1/4-inch Quilting Foot	SA125	F001N: XC1944-052
8	Narrow Hemmer Foot	SA127	F003N: XC1945-052
9	Blind Stitch Foot	SA134	F018N: XC1976-052
10	Quilting guide	SA132	F016N: XC2215-052



### Note

- The quilting guide can be inserted into the holes at the back of the walking foot or the black plastic hole at the top of sewing ankle.

## THE MAIN PARTS

1

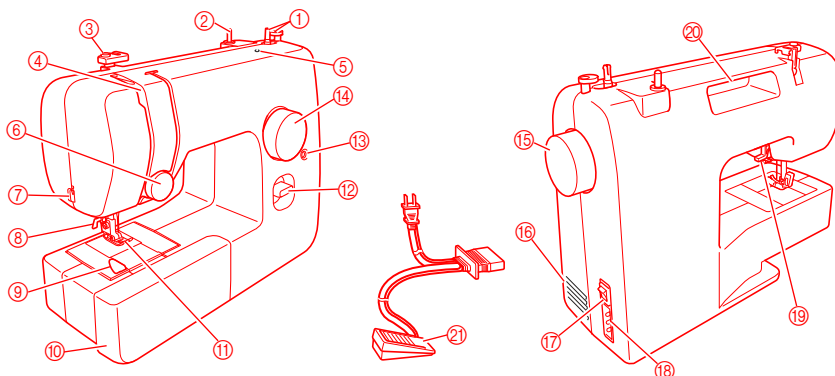

- ① **Bobbin winder (Page 13)**  
This winds the thread onto the bobbin for use as the lower thread.
- ② **Spool pin (Page 13, 17)**  
This holds the spool of thread.
- ③ **Thread guide (Page 13, 17)**  
This is used when winding the thread onto the bobbin and then threading the machine.
- ④ **Thread take-up lever (Page 18)**
- ⑤ **Hole for extra spool pin (Page 26)**  
This holds a second spool of thread for sewing with the twin needle.
- ⑥ **Upper tension-control dial (Page 27)**  
This controls the tension of the upper thread.
- ⑦ **Thread cutter (Page 24)**  
Pass the threads through the thread cutter to cut them.
- ⑧ **Needle threader (Page 19)**  
(This is only available on certain models.)
- ⑨ **Quick-set bobbin (Page 16, 21)**  
(This is only available on certain models.)
- ⑩ **Flat bed attachment with accessory compartment (Page 6)**
- ⑪ **Presser foot (Page 10)**
- ⑫ **Reverse sewing lever (Page 12)**  
Push this lever to stitch in the reverse direction.
- ⑬ **Buttonhole fine-adjustment screw (Page 34)**
- ⑭ **Pattern selection dial (Page 11)**  
Rotate the dial in either direction to choose the stitch you want.
- ⑮ **Handwheel**  
Used to manually raise and lower the needle.
- ⑯ **Air vent**  
The air vent allows the air surrounding the motor to circulate.  
Do not cover the air vent while the machine is being used.

- ⑰ **Main power and sewing light switch (Page 8)**  
You can turn the main power and sewing light switch on and off.
- ⑱ **Foot controller jack / socket (Page 7)**  
Plug in the foot controller plug and connect the machine to the power supply.
- ⑲ **Presser foot lever (Page 17)**  
Used to raise and lower the presser foot.
- ⑳ **Handle**  
Carry the machine by its handle when transporting.
- ㉑ **Foot controller (Page 8)**  
You can use this to control the sewing speed, and to start and stop sewing.

Foot Controller:

Model KD-1902 for 110-120V area  
KD-1902 for 110-127V area (Brazil only)

Model KD-2902 for 220-240V area

The foot controller part code differs depending on the country or region. Contact your Brother dealer or the nearest authorized Brother Service Center.

## Flat bed attachment

The accessories can be stored in a compartment inside the flat bed attachment.

- ① **Slide the flat bed attachment to the left to open it.**

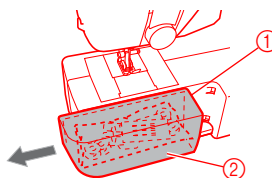

- ① Flat bed attachment
- ② Storage compartment

## USING YOUR SEWING MACHINE

### WARNING

- Use only regular household electricity for the power source. Using other power sources may result in fire, electric shock, or damage to the machine.
- Make sure that the plugs on the power cord are firmly inserted into the electrical outlet and the power supply jack on the machine. Otherwise, a fire or electric shock may result.
- Do not insert the plug on the power cord into an electrical outlet that is in poor condition.
- Turn off the main power and remove the plug in the following circumstances:
  - When you are away from the machine
  - After using the machine
  - When the power fails during use
  - When the machine does not operate correctly due to a bad connection or a disconnection
  - During electrical storms

### CAUTION

- Use only the power cord included with this machine.
- Do not use extension cords or multi-plug adapters with many other appliances plugged in to them. Fire or electric shock may result.
- Do not touch the plug with wet hands. Electric shock may result.
- When unplugging the machine, always turn off the main power first. Always grasp the plug to remove it from the outlet. Pulling on the cord may damage the cord, or lead to fire or electric shock.
- Do not allow the power cord to be cut, damaged, modified, forcefully bent, pulled, twisted, or bundled. Do not place heavy objects on the cord. Do not subject the cord to heat. These things may damage the cord and cause fire or electric shock. If the cord or plug is damaged, take the machine to your authorized Brother Service Center for repairs before continuing use.
- Unplug the power cord if the machine is not to be used for a long period of time. Otherwise a fire may result.

### Connecting plugs

- 1** Connect the foot controller plug to the machine.
- 2** Connect the power supply plug to a wall outlet.

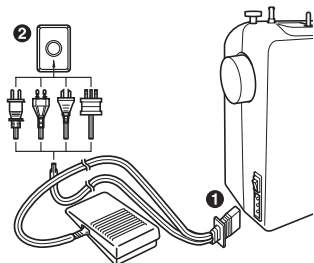

### Note

- If a power outage occurs while the sewing machine is being operated, turn off the main power and unplug the power supply cord. When restarting the sewing machine, follow the necessary procedure to correctly operate the machine.



## Main power and sewing light switch

This switch turns the main power and sewing light on or off.

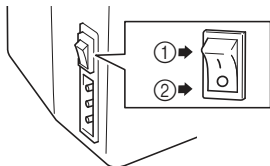

- ① Turn on (toward the 'I' mark)
- ② Turn off (toward the 'O' mark)

## CAUTION

- Do not turn on the machine while pressing down the foot controller. The machine may start unexpectedly and cause personal injury or damage to the machine.

## Foot controller

When you press the foot controller down lightly, the machine will run at a low speed. When you press harder, the machine's speed will increase. When you take your foot off the foot controller, the machine will stop.

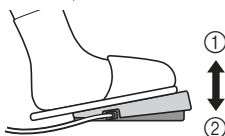

- ① Slower
- ② Faster

You should make sure that nothing is placed on the foot controller when the machine is not in use.

## CAUTION

- Do not allow pieces of cloth and dust to build up on the foot controller. Doing so could cause a fire or an electric shock.

## Checking the needle

The sewing needle must always be straight and sharp for smooth sewing.

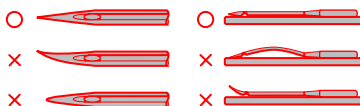

### ■ Checking the needle correctly

Put the flat side of the needle on a flat surface. Check the needle from the top and the sides. Dispose of any bent needles safely.

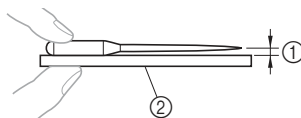

- ① Parallel space
- ② Level surface (bobbin cover, glass, etc.)

## Replacing the needle

### CAUTION

- Always turn off the machine before you change the needle. Otherwise, injuries may occur if the foot controller is accidentally pressed and the machine starts sewing.
- Only use sewing machine needles for home use. Other needles may bend or break and cause injury.
- Never sew with a bent needle. A bent needle will easily break and cause injury.

- 1 Turn off the machine.
- 2 Raise the needle by turning the handwheel toward you (counterclockwise) so that the mark on the wheel points up.
- 3 Lower the presser foot lever.

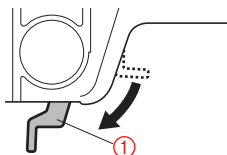

- ① Presser foot lever

**CAUTION**

- Before replacing the needle, place fabric or paper under the presser foot to prevent the needle from falling into the hole in the needle plate.

- 4** Hold the needle with your left hand, and then use a screwdriver to turn the needle clamp screw counterclockwise to remove the needle.

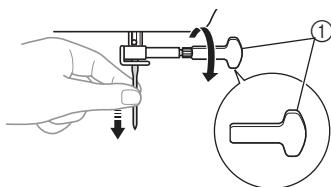

- ① Use a screwdriver
- Do not use excessive force when loosening or tightening the needle clamp screw, otherwise certain parts of the sewing machine may be damaged.

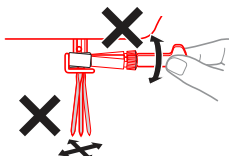

- 5** With the flat side of the needle toward the back of the machine, insert the needle until it touches the needle stopper. Next, tighten the needle clamp using a screwdriver.

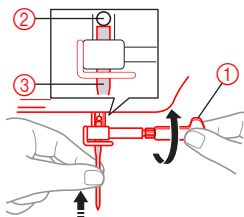

- ① Use a screwdriver  
② Needle stopper  
③ Needle

Install the twin needle in the same way.

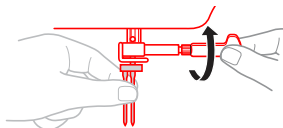

**CAUTION**

- Make sure you insert the needle until it touches the stopper, and securely tighten the needle clamp screw with a screwdriver, otherwise the needle may break or the machine may be damaged.

## Changing the presser foot

### CAUTION

- Always turn off the machine before you change the presser foot. If you leave the power on and step on the controller, the machine will start and you may be injured.
- Always use the correct presser foot for the stitch pattern you have chosen. If you use the wrong presser foot, the needle may strike the presser foot and bend or break, and may cause injury.
- Only use presser feet that have been designed to be used with this machine. Using any other presser foot may cause accident or injury.

You will have to change the presser foot depending on what you want to sew and how.

- 1** Turn off the machine. Raise the presser foot lever.
- 2** Raise the needle by turning the handwheel toward you (counterclockwise) so that the mark on the wheel points up.

**3**

Remove the presser foot by pulling it vertically downward.

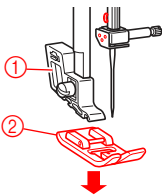

- ① Presser foot holder
- ② Presser foot

Press the black button at the back of the presser foot holder to release the presser foot.

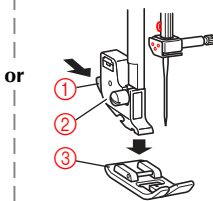

- ① Black button
- ② Presser foot holder
- ③ Presser foot



### Note

- Depending on the type of presser foot holder, the method of releasing the presser foot will vary.

- 4** Put a different presser foot on the needle plate so that the bar on the presser foot is in line with the slot on the shank.
- 5** Lower the presser foot lever and fix the presser foot onto the shank. If the presser foot is in the correct place, the bar should snap in.

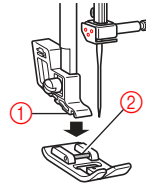

- ① Shank
- ② Bar

### ■ Presser foot installation orientation

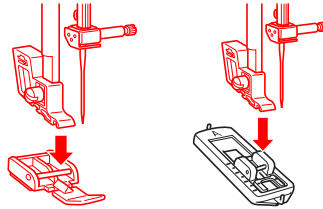

### CAUTION

- If the presser foot is not installed with the correct orientation, the needle may strike the presser foot, which may bend or break the needle and cause injury.

## THE CONTROLS

### Pattern selection dial

#### CAUTION

- When you use the pattern selection dial to choose a pattern, raise the needle by turning the handwheel toward you (counterclockwise) so that the mark on the wheel points up. If the needle is in the down position when you turn the pattern selection dial, the needle, presser foot or fabric may be damaged.

To choose a stitch, simply turn the pattern selection dial in either direction.

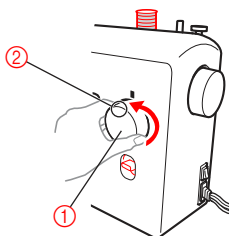

- ① Pattern selection dial
- ② Chosen pattern number

### Patterns and stitch names

\*1 : Stitch nos. 15-17 are only available on certain models.

Pattern	Preset Length (mm (inch))	Reference Page
Stitch Name	Preset Width (mm (inch))	
	0.5 (1/32)	33
4-STEP AUTOMATIC BUTTONHOLE	5 (3/16)	
	0.7 (1/32)	29, 36, 37, 39
ZIGZAG STITCH	1.8 (1/8)	
	1.5 (1/16)	29, 36, 37, 39
ZIGZAG STITCH	3.3 (3/16)	
	2 (1/16)	29, 36, 37, 39
ZIGZAG STITCH	5 (3/16)	
	0.5 (1/32)	29, 36
ZIGZAG (SATIN) STITCH	5 (3/16)	
	1.6 (1/16)	29, 38
STRAIGHT STITCH (Center Needle Position)	—	
	1.8 (1/8)	29, 38
STRAIGHT STITCH (Center Needle Position)	—	
	2 (1/16)	29, 38
STRAIGHT STITCH (Center Needle Position)	—	
	3 (1/8)	29, 35, 36, 38, 39
STRAIGHT STITCH (Center Needle Position)	—	

Pattern	Preset Length (mm (inch))	Reference Page
Stitch Name	Preset Width (mm (inch))	
10 ↓	4 (3/16)	29, 38
STRAIGHT STITCH (Center Needle Position)	—	
11 ↓	2.5 (3/32)	29, 36, 38
STRAIGHT STITCH (Left Needle Position)	—	
12 ~	2 (1/16)	30, 39
BLIND HEM STITCH	5 (3/16)	
13 ~	1 (1/16)	31
ELASTIC STITCH	5 (3/16)	
14 ~	2 (1/16)	30, 39
STRETCH BLIND HEM STITCH	5 (3/16)	
15 ~	2 (1/16)	31
OVEREDGE STITCH	5 (3/16)	
16 ~	1.2 (1/16)	32
DOUBLE ACTION STITCH	5 (3/16)	
17 ~	1.2 (1/16)	32
BRIDGING STITCH	5 (3/16)	

## Reverse sewing lever

You can use reverse sewing for back tacking and reinforcing seams.

To sew in reverse, push the reverse sewing lever in as far as possible and hold it in that position while you lightly push the foot controller. To sew forward, release the reverse sewing lever. The machine will then sew forward.

The length of reverse stitches is fixed at 2 mm (1/16 inch).

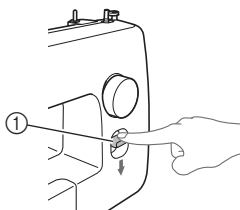

① Reverse sewing lever

## THREADING THE MACHINE

### Winding the bobbin

#### CAUTION

- We designed the bobbin that comes with this machine. If you use bobbins from other models, the machine will not work properly. Only use the bobbin that comes with this machine or bobbins of the same type (part code: SA156, SFB: XA5539-151). Using other bobbins may cause damage to the machine. SA156 is Class 15 type bobbin.

Actual size

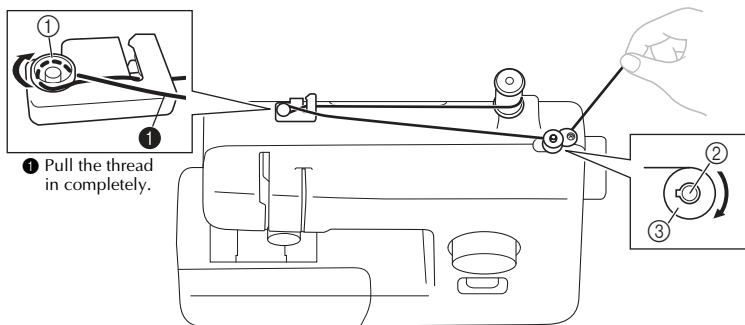
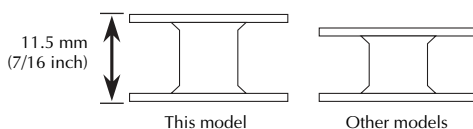

① Pull the thread in completely.

① Pre-tension disk

② Bobbin winder shaft

③ Bobbin

- 1 Pull up the spool pin and put a spool of thread on this pin.

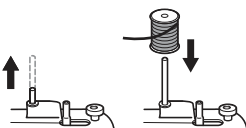

- 2 While holding the thread from the spool with your right hand, pass the thread toward you, in the groove on the thread guide. Then, pass the thread around the pre-tension disk and pull the thread in completely.

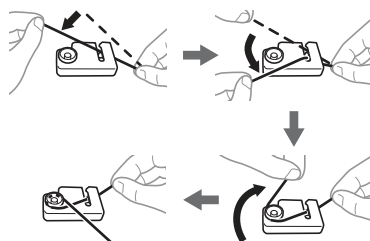

#### CAUTION

- If the spool of thread is in the wrong place, or is set incorrectly, the thread may tangle on the spool pin.

**3** Pass the end of the thread through the hole on the bobbin from the inside of the bobbin.

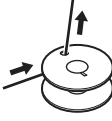

**4** Put the bobbin onto the bobbin winder shaft and slide the bobbin winder shaft to the right. Turn the bobbin clockwise, by hand, until the projection slides into the notch of the bobbin.

- Make sure to pull out 7 to 10 cm (3-4 inches) of thread from the hole on the bobbin.

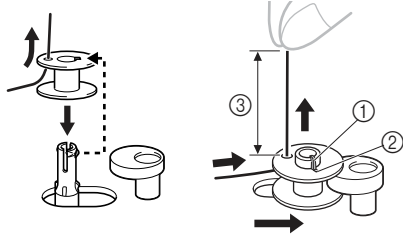

- ① Projection
- ② Notch
- ③ 7-10 cm (3 – 4 inches)

**! CAUTION**

- Pull the thread taut and hold the end of the thread straight up. If the thread is too short, not pulled taut or held at an angle, injuries may occur when the thread is wound around the bobbin.

**5** Turn on the machine.

**! CAUTION**

- Do not turn on the machine while pressing down the foot controller. The machine may start unexpectedly and cause personal injury or damage to the machine.

**6** While holding the end of the thread, gently press the foot controller to wind the thread around the bobbin a few times. Then stop the machine.

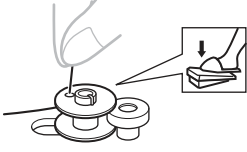

**7** Trim the excess thread above the bobbin.

- Leave 1 cm (1/2 inch) of thread from the hole on the bobbin.



- ① 1 cm (1/2 inch)

**! CAUTION**

- Make sure you follow the instructions carefully. If you do not cut the excess thread completely before winding the bobbin, when the thread runs low it may tangle around the bobbin and cause the needle to break.

**8** Press the foot controller to start.

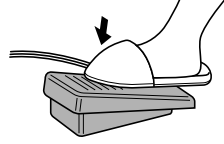

**9** When the bobbin seems full and begins spinning slowly, take your foot off the foot controller.

**10** Cut the thread, slide the bobbin winder shaft to the left and remove the bobbin.

**Note**

- When the sewing machine is started or the handwheel is turned after winding the thread around the bobbin, the machine will make a clicking sound; this is not a malfunction.
- The needle bar does not move when you slide the bobbin winder shaft to the right.

**! CAUTION**

- Not winding the bobbin properly may cause the thread tension to loosen, and may break the needle.

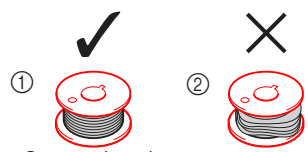

- ① Wound evenly
- ② Wound poorly

## Lower threading

Install the bobbin wound with thread.

- For more details on using the quick-set bobbin, see page 16.

### CAUTION

- Make sure you turn off the machine while threading. If you accidentally step on the foot controller and the machine starts to sew, you could be injured.

- 1 Prepare the bobbin wound properly before threading the lower thread.
  - See page 13 for the details about bobbin winding.
- 2 Raise the needle by turning the handwheel toward you (counterclockwise) and raise the presser foot lever.
- 3 Remove the bobbin cover by sliding it and lift toward you.

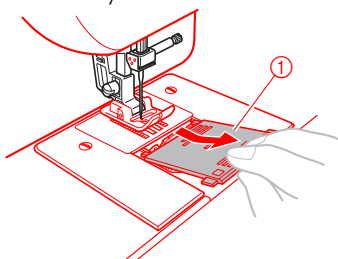

① Bobbin cover

- 4 Put the bobbin in so the thread comes out in the direction shown by the arrow.

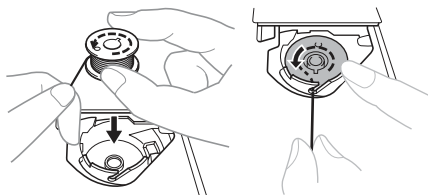

### CAUTION

- Make sure you set the bobbin so the thread unrolls in the right direction. If the thread unrolls in the wrong direction, it may cause the thread tension to be incorrect or break the needle.

- 5 Hold the end of the thread, push the bobbin down with your finger, and then pass the thread through the slit, as shown.

- If the thread is not correctly inserted through the tension-adjusting spring of the bobbin case, it may cause incorrect thread tension.

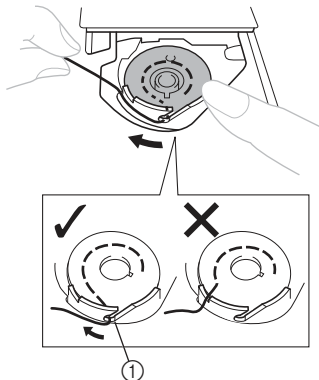

① Tension-adjusting spring

- 6 Replace the bobbin cover. Put the projection into the bobbin race retainer groove and push closed.

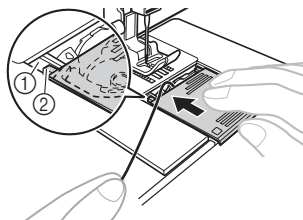

① Groove  
② Projection

- Make sure that the end of the thread comes out from the cover toward the rear of the machine (as shown in the illustration).
- Draw up the lower thread before starting sewing. Refer to "Drawing up the lower thread" on page 21 after threading the upper thread.



## Lower threading (for models equipped with a quick-set bobbin)

Install the bobbin wound with thread.  
This feature is only available on certain models.

- 1 Follow steps 1 to 4 from “Lower threading” on page 15.
- 2 While lightly holding down the bobbin with your right hand as shown, guide the thread through the slit (1 and 2). Then, pull the thread toward you to cut it with the cutter (3).

- At this time, check that the bobbin easily rotates counterclockwise.

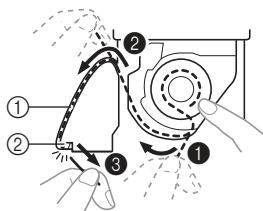

- 1 Slit
- 2 Cutter (Cut the thread with the cutter.)

### Note

- If the thread is not correctly inserted through the tension-adjusting spring of the bobbin case, it may cause incorrect thread tension.

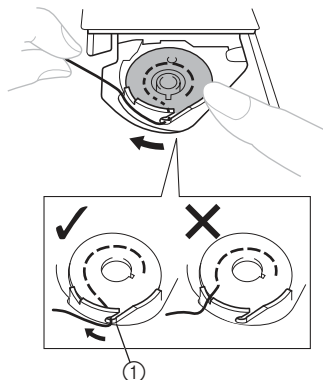

- 1 Tension-adjusting spring

- 3 Replace the bobbin cover. Put the projection into the race retainer groove and push closed.

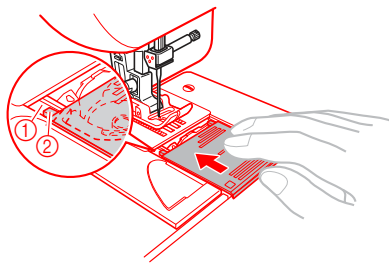

- 1 Groove
- 2 Projection

- Start sewing after threading the lower and upper thread. When sewing gathers or darts, you can draw up the lower thread by hand so that some thread will be left over. Refer to the steps in “Drawing up the lower thread” (page 21).

## Upper threading

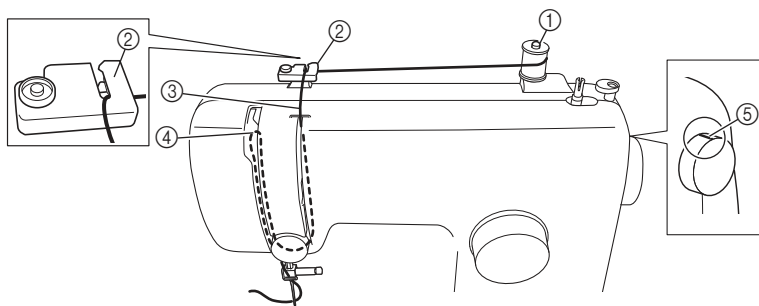

- ① Spool pin
- ② Thread guide (back)
- ③ Thread guide (front)

- ④ Thread take-up lever
- ⑤ Mark on the handwheel

### ! CAUTION

- When threading the upper thread, carefully follow the instructions. If the upper threading is not correct, the thread may become tangled or the needle may bend or break.
- Never use a thread weight of 20 or lower.
- Use the needle and the thread in the correct combination. For details on the correct combination of needles and threads, refer to "FABRIC, THREAD, AND NEEDLE COMBINATIONS" on page 22.

**1** Turn off the machine.

**2** Raise the presser foot lever.

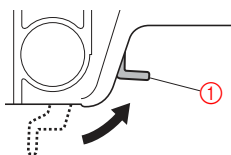

- ① Presser foot lever

**3** Raise the needle by turning the handwheel toward you (counterclockwise) so that the mark on the wheel points up.

- If the needle is not correctly raised, the sewing machine can not be threaded.

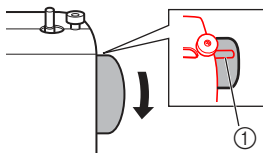

- ① Mark on the wheel

**4** Pull up the spool pin and put a spool of thread on this pin.

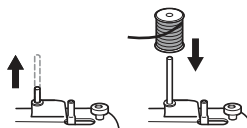

### ! CAUTION

- If the spool of thread is in the wrong place, or is set incorrectly, the thread may tangle on the spool pin and cause the needle to break.

- 5** While holding the thread from the spool with your right hand, pass the thread toward you, in the groove on the thread guide.

- Make sure that the spring in the groove catches the thread.



① Spring

- 6** Feed the upper thread as shown in the following illustration.

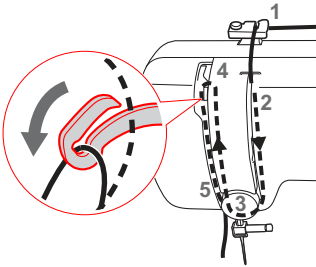

- 7** Make sure you guide the thread through the thread take-up lever from right to left as shown in the following illustration.

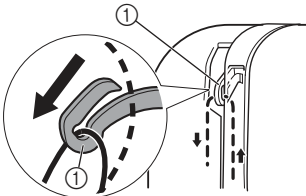

① Thread take-up lever



### Memo

- If the thread take-up lever is lowered, the upper thread can not be wrapped around the thread take-up lever. Make sure you raise the needle by turning the handwheel toward you (counterclockwise) so that the mark on the wheel points up.

- 8** Put the thread behind the guide above the needle.

- The thread can easily be passed behind the needle bar thread guide by holding the thread in your left hand, then feeding the thread with your right hand.

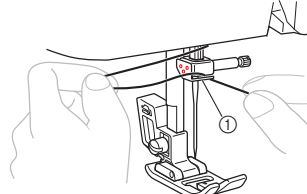

① Needle bar thread guide

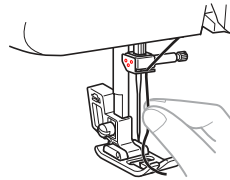

- 9** Thread the needle from front to back leaving a thread tail of about 5 cm (2 inches).

- If your sewing machine is equipped with a needle threader, use the needle threader to thread the needle (see next section).

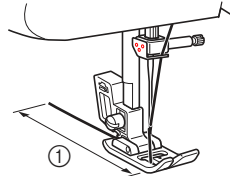

① 5 cm (2 inches)



### Note

- Make sure you raise the presser foot lever and the thread take-up lever before you feed the upper thread.
- If you incorrectly feed the thread you may cause sewing problems.

## Using the needle threader (for models equipped with a needle threader)

This feature is only available on certain models.

### ⚠ CAUTION

- The needle threader can be used with a 75/11 through 100/16 home sewing machine needle. However, the needle threader cannot be used with a 65/9 home sewing machine needle. When using special thread such as transparent nylon thread or metallic thread, the needle threader cannot be used.
- Thread with a thickness of 130/120 or thicker cannot be used with the needle threader.
- The needle threader cannot be used with the wing needle or the twin needle.
- If the needle threader cannot be used, refer to "Upper threading" on page 17.

- 1 Follow steps ① to ③ from "Upper threading" on page 17 before using the needle threader.
- 2 Lower the presser foot lever.
- 3 Make sure that the mark on the wheel points up as shown in the following illustration.

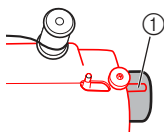

① Mark on the wheel

- 4 While lowering the needle threader lever, hook the thread onto the guide.

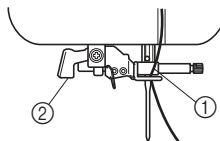

① Needle holder  
② Needle threader lever

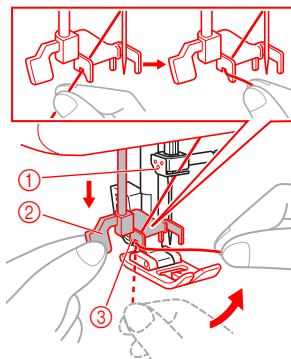

① Needle holder  
② Needle threader lever  
③ Guide

- 5 Pull down the needle threader lever as much as possible, and then turn the lever toward the back of the machine (away from you). Make sure that the hook passes through the eye of the needle and grabs the thread.

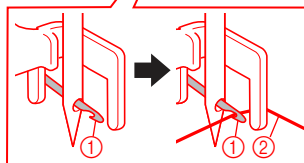
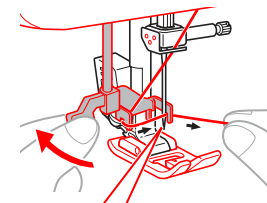

① Hook  
② Thread

- Hold the thread in front of the needle to make sure that the hook grabs it.

- 6** While lightly holding the thread, turn the needle threader lever toward the front of the machine (toward you). The hook will pull the thread through the needle.

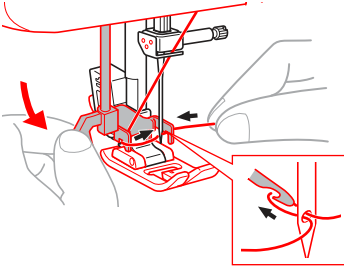

- 7** Raise the needle threader lever.

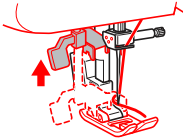

- 8** Pull the loop of the thread passed through the eye of the needle toward the rear of the machine.

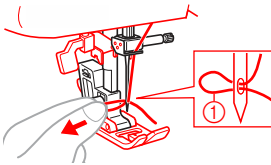

① Loop of thread

### **!** CAUTION

- Be careful not to pull on the thread with force or it may bend the needle.
- If the thread does not pass through the eye of the needle, start from step ⑥ again.

- 9** Raise the presser foot lever.

- 10** Pass the end of the thread through the presser foot, and then pull out about 5 cm (2 inches) of thread toward the rear of the machine.

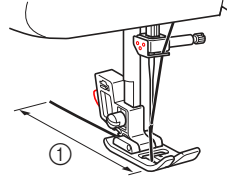

① 5 cm (2 inches)

### **⚡** Note

- If you incorrectly feed the thread you may cause sewing problems.

## Drawing up the lower thread

- 1 While lightly holding the end of the upper thread, slowly turn the handwheel toward you (counterclockwise) by hand to lower and then raise the needle.

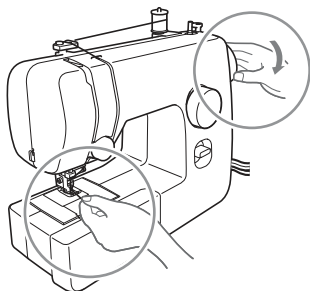

- 2 Pull on the upper thread to draw up the lower thread.

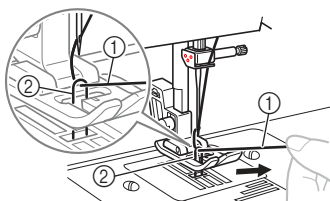

- ① Upper thread
- ② Lower thread

- 3 Pull out about 10 cm (4 inches) of both threads and put them toward the back of the machine under the presser foot.

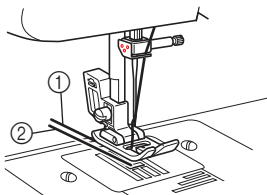

- ① Upper thread
- ② Lower thread

## For models equipped with a quick-set bobbin

You can begin sewing immediately without drawing up the bobbin thread.

When sewing gathers or darts, you can draw up the lower thread by hand so that some thread will be left over. Before you draw up the lower thread, put the bobbin back in.

- 1 Remove the bobbin cover, and then reinstall the bobbin.
- 2 Pass the thread along the slit in the direction of the arrow, and leave it there without cutting it.

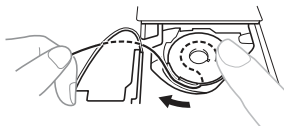

- The bobbin cover should still be removed.

- 3 Draw up the lower thread as described in the previous steps 1 to 3.
- 4 Replace the bobbin cover.

## FABRIC, THREAD, AND NEEDLE COMBINATIONS

Fabric Type/Application		Thread		Size of Needle
		Type	Size	
Medium weight fabrics	Broadcloth	Cotton thread	60–90	75/11–90/14
	Taffeta	Synthetic thread		
	Flannel, Gabardine	Silk thread	50	
Thin fabrics	Lawn	Cotton thread	60–90	65/9–75/11
	Georgette	Synthetic thread		
	Challis, Satin	Silk thread	50	
Thick fabrics	Denim	Cotton thread	30	100/16
			50	90/14–100/16
	Corduroy	Synthetic thread	50–60	
	Tweed	Silk thread		
Stretch fabrics	Jersey	Thread for knits	50–60	Ball point needle 75/11–90/14 (gold colored)
	Tricot			
Easily frayed fabrics		Cotton thread	50–90	65/9–90/14
		Synthetic thread		
		Silk thread	50	
For top-stitching		Synthetic thread	30	100/16
		Silk thread	50–60	75/11–90/14



### Note

- Never use a thread weighted #20 or lower. It may cause machine malfunction.



### Memo

- The lower the thread number, the thicker the thread; and the higher the needle number, the thicker the needle.

### ■ Ball point needle

Use the ball point needle when sewing on stretch fabrics or fabrics where skipped stitches easily occur.

### ■ Transparent nylon thread

Use a 90/14 to 100/16 needle, regardless of the fabric or thread.



## CAUTION

- Make sure you follow the needle, thread, and fabric combinations listed in the table. Using the wrong combination, such as heavyweight fabric like denim with a small needle (65/9-75/11), may bend or break the needle. The wrong combination may also cause the seam to be uneven, the fabric to pucker, or the machine to skip stitches.

## 2 SEWING BASICS

Please read before sewing

### CAUTION

- To avoid being injured, watch the needle carefully while you are using the machine. Keep your hands away from moving parts.
- Do not stretch or pull the fabric during sewing, otherwise the needle may be damaged and you may be injured.
- Do not use bent or broken needles, otherwise you may be injured.
- Take care that the needle does not hit basting pins or other objects during sewing. The needle may break and you may be injured.
- Always use the correct presser foot. If you use the wrong presser foot, the needle may hit the presser foot and bend or break and you may be injured.
- When you turn the handwheel by hand, always turn it toward you (counterclockwise). Turning it the other way may cause the thread to tangle and damage the needle or fabric, and you may be injured.
- Do not start sewing without placing the fabric under the presser foot, otherwise the presser foot may be damaged.

### Starting sewing

- 1 Turn on the machine.



### CAUTION

- Do not turn on the machine while pressing down the foot controller. The machine may start unexpectedly and cause personal injury or damage to the machine.

- 2 Raise the needle by turning the handwheel toward you (counterclockwise) so that the mark on the wheel points up.
- 3 Turn the pattern selection dial to select a stitch (see page 11).
- 4 Change the presser foot (see page 10).

- 5 Raise the presser foot lever.

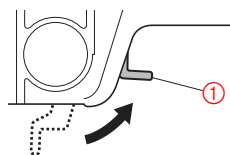

① Presser foot lever

- 6 Place the fabric under the presser foot, pass the thread under the presser foot, and then pull out about 5 cm (2 inches) of thread toward the rear of the machine.

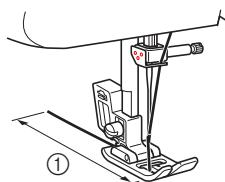

① 5 cm (2 inches)



- 7** While holding the end of the thread and the fabric with your left hand, turn the handwheel toward you (counterclockwise) with your right hand to lower the needle to the starting point of the stitching.

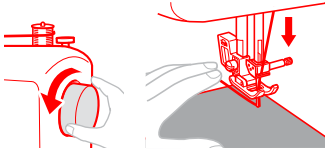

- 8** Lower the presser foot lever.

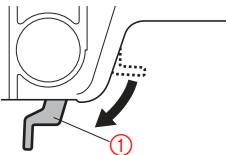

① Presser foot lever

- 9** Slowly press down on the foot controller.

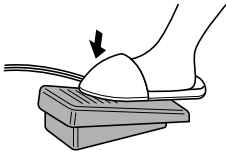

▶ The machine starts sewing.

- 10** Take your foot off the foot controller.

▶ The machine stops sewing.

- You can use reverse sewing for back tacking and reinforcing seams by pressing the reverse sewing lever. Refer to "Reverse sewing lever" on page 12 for the details.

- 11** Raise the needle by turning the handwheel toward you (counterclockwise).

- 12** Raise the presser foot lever.

- 13** Pull the fabric to the left side of the machine, and then pass the threads through the thread cutter to cut them.

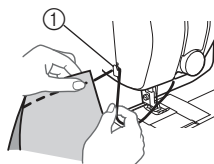

① Thread cutter

## Trial sewing

A trial piece of fabric should be sewn. Use a piece of fabric and thread that are the same as those used for your project, and check the thread tension and stitch length and width.

## Changing the sewing direction

Stop the machine with the needle in the fabric at the point where you want to change the sewing direction, and then raise the presser foot lever. Using the needle as a pivot, turn the fabric, lower the presser foot lever, and then continue sewing.

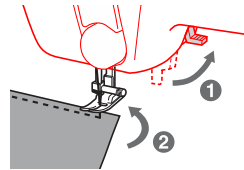

## Sewing thick fabrics

- If the fabric does not fit under the presser foot

If the fabric does not fit easily under the presser foot, raise the presser foot lever even higher to bring the presser foot to its highest position.

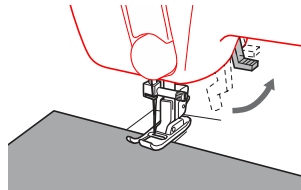

## CAUTION

- If fabric more than 6 mm (15/64 inch) thick is sewn or if the fabric is pushed with too much force, the needle may bend or break.

## Sewing thin fabrics

When sewing thin fabrics, the stitching may become misaligned or the fabric may not feed correctly. If this occurs, place thin paper or stabilizer material under the fabric and sew it together with the fabric. When you have finished sewing, tear off any excess paper.

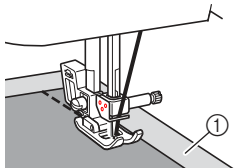

① Stabilizer material or paper

## Sewing stretch fabrics

First, baste the pieces of fabric together, and then sew without stretching the fabric.

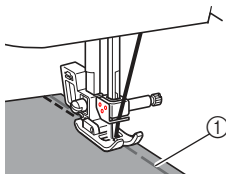

① Basting

## Stitching cylindrical pieces

Removing the flat bed attachment makes it easier to sew cylindrical pieces such as cuffs and pant legs, or hard-to-reach areas.

- 1 Slide the flat bed attachment to the left to release it.

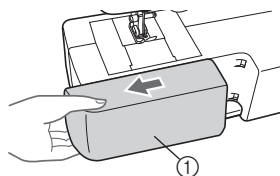

① Flat bed attachment

- ▶ With the flat bed attachment removed, free-arm sewing is possible.



### Note

- When you are finished with free-arm sewing, install the flat bed attachment back in its original position.

- 2 Slide the part that you wish to sew onto the arm, and then sew from the top.

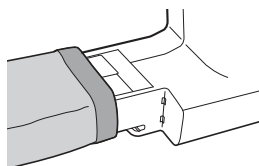

## Sewing with a twin needle (Option)

We have designed your machine so you can sew with this needle and two top threads. You can use the same color or two different colors of thread for making decorative stitches.



Twin needle



Extra spool pin

## CAUTION

- Use only twin needles that have been made for this machine (part code: X57521-021:2.0/75 with a 2 mm width). Other needles could break and damage the machine.
- Make sure that the needle does not strike the presser foot.
- Do not sew with bent needles. The needle could break and injure you.

### Attaching the twin needle

Attach the twin needle in the same way as a single needle (see page 8–9). The flat side of the needle should face toward the back and the rounded side should face toward you.

## ■ Attaching the extra spool pin

Put the extra spool pin in the hole on the top of the machine. Put the second spool of thread onto the extra spool pin.

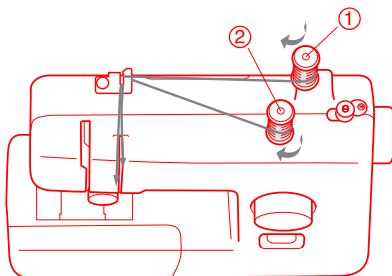

- ① First spool
- ② Second spool

## ■ Twin needle threading

You should thread each needle separately.



### Note

#### Models equipped with a needle threader

- You cannot use the needle threader to thread the twin needle. Instead, thread the twin needle by hand, from front to back. Using the needle threader may damage the machine.

### 1 Use the thread from the first spool to thread the machine to the needle bar thread guide.

The path for threading the machine to the needle bar thread guide is the same as for normally threading the machine (for a single needle). See page 18 for more details.

### 2 Thread the left needle from front to back.

### 3 Use the thread from the second spool to thread the machine to the thread take-up lever.

The path for threading the machine to the thread take-up lever is the same as for normally threading the machine (for a single needle). See page 18 for more details.

### 4 Thread the right needle from front to back.

Do not pass the thread behind the needle bar thread guide.

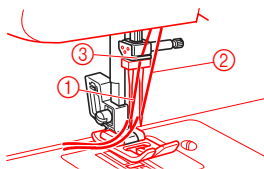

- ① Left needle thread passes through the needle bar thread guide.
- ② Right needle thread passes in front of the needle bar thread guide.
- ③ Needle bar thread guide

### 5 Attach zigzag foot “J”.

For details on changing the presser foot, refer to “Changing the presser foot” on page 10.

## ⚠ CAUTION

- When using the twin needle, be sure to attach zigzag foot “J”, otherwise the needle may break or the machine may be damaged.

### 6 Turn on the machine.

## ⚠ CAUTION

- Do not turn on the machine while pressing down the foot controller. The machine may start unexpectedly and cause personal injury or damage to the machine.

## 7 Select a stitch.

### CAUTION

- After selecting a stitch, slowly turn the handwheel toward you (counterclockwise) and check that the needle does not touch the presser foot. If the needle hits the presser foot, the needle may bend or break.
- The twin needle should only be used with the Straight Stitch (Center Needle Position) and the Zigzag Stitch (1.5 mm (1/16 inch) width). Do not use the twin needle with any other stitches.

## 8 Start sewing.

For details on starting to sew, refer to “Starting sewing” on page 23.

- ▶ Two lines of stitching are sewn parallel to each other.



### CAUTION

- When changing the sewing direction, be sure to raise the needle from the fabric, and then raise the presser foot lever and turn the fabric. Otherwise the needle may break or the machine may be damaged.

## Thread tension

The tension of the thread will affect the quality of your stitches. You may need to adjust it when you change fabric or thread.

### Memo

- We recommend that you do a test sample on scrap of a fabric before you start to sew.

### Correct tension

Correct tension is important as too much or too little tension will weaken your seams or cause puckers on your fabric.

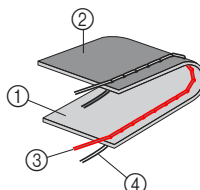

- ① Surface of fabric
- ② Back of fabric
- ③ Upper thread
- ④ Lower thread

### Upper tension is too tight

Loops will appear on the surface of the fabric.

### Note

- If the bobbin thread was incorrectly threaded, the upper thread may be too tight. In this case, refer to “Lower threading” on page 15 and rethread the bobbin thread.

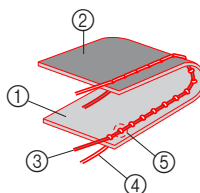

- ① Surface of fabric
- ② Back of fabric
- ③ Upper thread
- ④ Lower thread
- ⑤ Loops appear on surface of fabric

### Solution

Reduce the tension by turning the upper tension control dial to a lower number.

## ■ Upper tension is too loose

Loops appear on the back of the fabric.



### Note

- If the upper thread was incorrectly threaded, the upper thread may be too loose. In this case, refer to “Upper threading” on page 17 and rethread the upper thread.

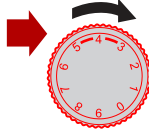
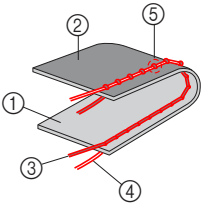

- ① Surface of fabric
- ② Back of fabric
- ③ Upper thread
- ④ Lower thread
- ⑤ Loops appear on back of fabric

### Solution

Increase the tension by turning the upper tension control dial to a higher number.

### 3 BUILT-IN STITCHES

#### Straight stitching

Straight stitches are used for sewing plain seams.

Stitch Name	Pattern	Stitch Length [mm (inch)]
Straight Stitch (Center Needle Position)	6 — —	1.6 (1/16)
Straight Stitch (Center Needle Position)	7 — —	1.8 (1/8)
Straight Stitch (Center Needle Position)	8 — —	2 (1/16)
Straight Stitch (Center Needle Position)	9 — —	3 (1/8)
Straight Stitch (Center Needle Position)	10 — —	4 (3/16)
Straight Stitch (Left Needle Position)	11 — —	2.5 (3/32)

#### ■ Top stitching and stretch materials

You can use a straight stitch for top stitching and sewing lightweight fabrics.

#### Zigzag stitching

Stitch Name	Pattern	Stitch Length [mm (inch)]	Stitch Width [mm (inch)]
Zigzag Stitch	2 ~	0.7 (1/32)	1.8 (1/8)
Zigzag Stitch	3 ~	1.5 (1/16)	3.3 (3/16)
Zigzag Stitch	4 ~	2 (1/16)	5 (3/16)
Zigzag (Satin) Stitch	5 ~	0.5 (1/32)	5 (3/16)

#### ■ Zigzag stitch

Turn the pattern selection dial to the Zigzag Stitch, and then start sewing.

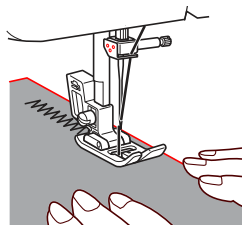

We recommend that you sew using the Straight Stitch at the beginning and end of Zigzag Stitches. (This acts as a reinforcement stitch.)



#### ■ Zigzag (Satin) Stitch

You can use the Zigzag (Satin) Stitch for making decorative stitches.

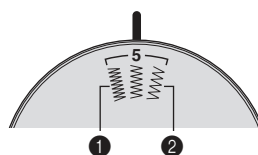

When sewing a Zigzag (Satin) Stitch, use a slightly looser upper-thread tension to produce more beautiful stitches.

With the pattern selection dial, the Zigzag (Satin) Stitch (number 5) can be set to one of three stitch lengths. The middle position is the setting for the standard stitch length.



- 1 For a shorter stitch length, turn the pattern selecting dial to the left position of Zigzag (Satin) Stitch (number 5).
- 2 For a longer stitch length, turn the pattern selecting dial to the right position of Zigzag (Satin) Stitch (number 5).

## Blind hem stitching

Stitch Name	Pattern	Stitch Length [mm (inch)]	Stitch Width [mm (inch)]
Blind Hem Stitch		2 (1/16)	5 (3/16)
Stretch Blind Hem Stitch		2 (1/16)	5 (3/16)



### Memo

- When the size of cylindrical pieces is too small to slide onto the arm or the length is too short, the fabric will not feed and desired results may not be achieved.

### 1 Reverse the skirt or pants.

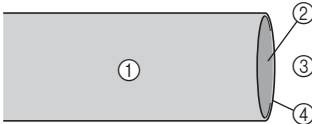

- ① Wrong side of fabric
- ② Right side of fabric
- ③ Bottom side
- ④ Edge of fabric

### 2 Fold the fabric along the desired edge of the hem, and press.

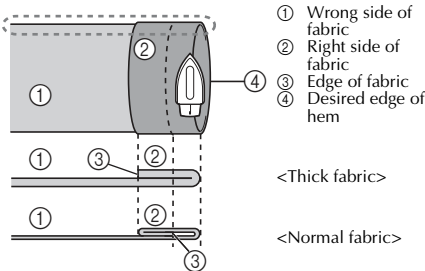

<Seen from the side>

### 3 Use a chalk to mark on the fabric about 5 mm (3/16 inch) from the edge of the fabric, and then baste it.

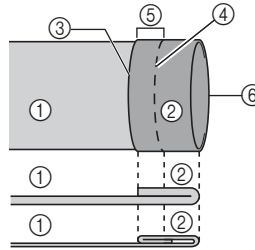

<Seen from the side>

- ① Wrong side of fabric
- ② Right side of fabric
- ③ Edge of fabric
- ④ Basting stitching
- ⑤ 5 mm (3/16 inch)
- ⑥ Desired edge of hem

<Thick fabric>

<Normal fabric>

### 4 Fold back the fabric inside along the basting.

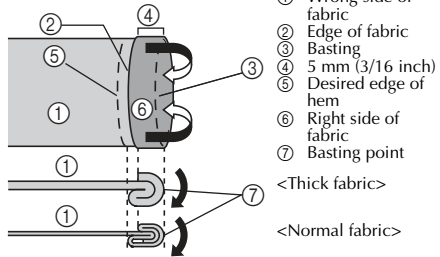

<Seen from the side>

- ① Wrong side of fabric
- ② Edge of fabric
- ③ Basting
- ④ 5 mm (3/16 inch)
- ⑤ Desired edge of hem
- ⑥ Right side of fabric
- ⑦ Basting point

<Thick fabric>

<Normal fabric>

### 5 Unfold the edge of fabric, and position the fabric with the wrong side facing up.

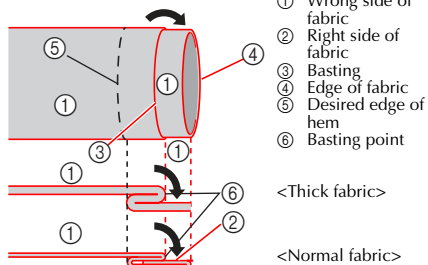

<Seen from the side>

- ① Wrong side of fabric
- ② Right side of fabric
- ③ Basting
- ④ Edge of fabric
- ⑤ Desired edge of hem
- ⑥ Basting point

<Thick fabric>

<Normal fabric>

### 6 Remove the flat bed attachment and make free-arm sewing possible.

- For details on free-arm sewing, refer to "Stitching cylindrical pieces" (Page 25).

- 7** Slide the part that you wish to sew onto the arm, make sure that the fabric feeds correctly, and then start sewing.

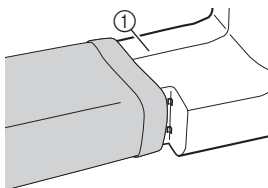

① Arm

- 8** After selecting a stitch, slowly turn the handwheel toward you (counterclockwise) until the needle has moved from the right side to the left.
- 9** Position the fabric under the presser foot, and then adjust the fabric position until the needle slightly catches the fold of the hem when the needle comes to the left end of the stitch.

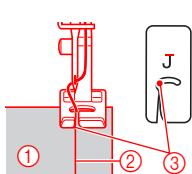

① Wrong side of fabric  
② Fold of hem  
③ Needle drop point

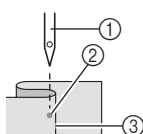

① Needle  
② Needle drop point  
③ Fold of hem

- 10** Lower the presser foot lever.
- 11** Sew at a slow speed holding the fabric with your hands, so that the needle slightly catches the fold of the hem.
- 12** Remove the basting stitching and turn the fabric right side up.

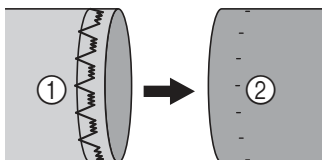

① Wrong side of fabric      ② Right side of fabric

## Overedge stitching

Stitch Name	Pattern	Stitch Length [mm (inch)]	Stitch Width [mm (inch)]
Overedge Stitch	15 	2 (1/16)	5 (3/16)

\* Stitch no. 15 is only available on certain models.

- 1** Put the fabric under the presser foot so that the seamline (or arrowhead point) is approximately 3 mm (1/8 inch) to the left of the center of the presser foot.

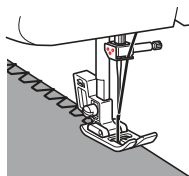

- If the seam allowance is wider than the stitch pattern, trim away any excess fabric after stitching.

## Elastic stitching

Stitch Name	Pattern	Stitch Length [mm (inch)]	Stitch Width [mm (inch)]
Elastic Stitch	13 	1 (1/16)	5 (3/16)

You can use the Elastic Stitch for mending, sewing elastic or joining fabric. Each is explained below.



## ■ Mending

**1** Place the reinforcement fabric under the area you want to mend.

- Use the basting pins to hold the reinforcement fabric.

**2** Following the line of the tear, sew using the Elastic Stitch as shown.

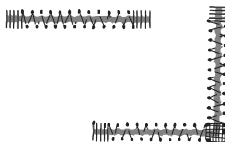

## ■ Sewing elastic

**1** Pin the elastic tape to the wrong side of the fabric.

**2** As you sew, stretch the elastic in front of and behind the presser foot.

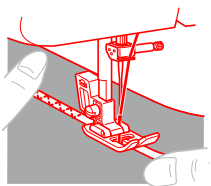

## ■ Joining fabric

You can use the Elastic Stitch to join two pieces of fabric together and it is very effective when sewing knitted fabrics. If you are using nylon thread, the stitch will not be visible.

**1** Put the edge of the two pieces of fabric together and center them under the presser foot.

**2** Sew them together using the Elastic Stitch. Make sure you keep the two fabric edges close together.

- Use the basting pins to hold the two fabric edges close together.

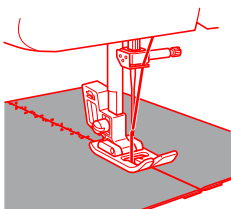

## Double action stitching

Stitch Name	Pattern	Stitch Length [mm (inch)]	Stitch Width [mm (inch)]
Double Action Stitch	16 	1.2 (1/16)	5 (3/16)
Bridging Stitch	17 	1.2 (1/16)	5 (3/16)

\* Stitch nos. 16-17 are only available on certain models.

These stitches are used for joining two pieces of fabric, such as when making patchwork.

Example: Patchwork with Double Action Stitch

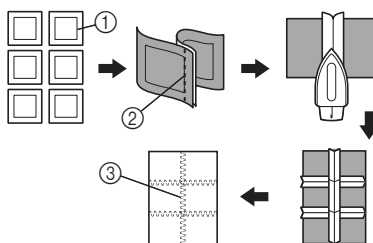

- ① Desired seamline
- ② Straight Stitch
- ③ Double Action Stitch

## 4 SEWING BUTTONHOLES

### CAUTION

- Always turn off the machine before replacing the presser foot. Otherwise, injuries may occur if the foot controller is accidentally pressed and the machine starts sewing.

### Making a buttonhole

Pattern	Stitch Length [mm (inch)]	Stitch Width [mm (inch)]	Foot
	0.5 (1/32)	5 (3/16)	Button-hole Foot "A"

### Memo

- We recommend that you practice making a buttonhole on a scrap piece of fabric before you try it on an actual garment.
- When making buttonholes on soft fabrics, place a stabilizer material on the underside of the fabric.

- Using tailor's chalk, mark the position and length of the buttonhole on the fabric.

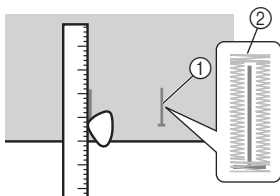

- Marks on fabric
- Buttonhole sewing

- Attach the buttonhole foot and push the frame back until it stops with the plastic insert at the front of the frame.

### CAUTION

- If the presser foot is not installed with the correct orientation, the needle may strike the presser foot, which may bend or break the needle and cause injury. (See page 10 for the correct presser foot orientation.)

- You need to sew the front bar tack first. Line the bar tack mark under the center of the presser foot and match it up to the two lines on the presser foot.

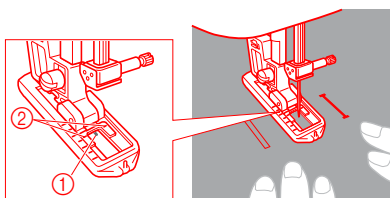

- Front of chalk mark
- Red lines

### ■ Making a Buttonhole

Step	Sewn section	Pattern
Step 1 (Front bar tack)		
	<ol style="list-style-type: none"> <li>Set the pattern selection dial to "a".</li> <li>Lower the presser foot and sew 5 to 6 stitches.</li> <li>Stop the machine when the needle is at the left side of the stitches and then raise the needle from the material.</li> </ol>	
Step 2 (Left side)		
	<ol style="list-style-type: none"> <li>Turn the pattern selection dial to "b".</li> <li>Sew the length of the tailor's chalk line.</li> <li>Stop the machine when the needle is at the left side of the stitch and then raise the needle.</li> </ol>	

Step	Sewn section	Pattern
Step 3 (Back bar tack)		
1. Turn the pattern selection dial to "c" (same position as in step 1). 2. Sew 5 to 6 stitches. 3. Stop the machine when the needle is at the right side of the stitch and then raise the needle from the material.		
Step 4 (Right side)		
1. Set the pattern selection dial to "d". 2. Sew the right side until the needle reaches the stitches sewn in step 1.		

## ■ Securing the Stitching and Cutting the Buttonhole

- 1 To secure the stitching, turn the material 90 degrees counterclockwise and sew straight stitches to the end of the front bar tack of the buttonhole.
- 2 Remove the material from the machine. We recommend that you put pins across both ends of the buttonhole to prevent the stitches from being cut.
- 3 Cut an opening in the middle of the buttonhole with the seam ripper tool. Be careful not to cut through any stitches.

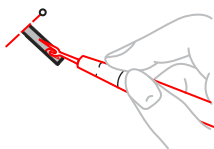

## ! CAUTION

- When using the seam ripper to open the buttonhole, do not put your hand or finger in the path of the ripper. The seam ripper may slip and you may be injured.

## Adjusting buttonholes

If the stitching on the two sides of the buttonhole is not the same, you can make the following adjustments.

- 1 After sewing the left side of the buttonhole, stitch the right side and observe the feeding.



① Right row

- 2 If the left side is too open or tight compared with the right side, adjust the buttonhole fine-adjustment screw as described in the following paragraphs.

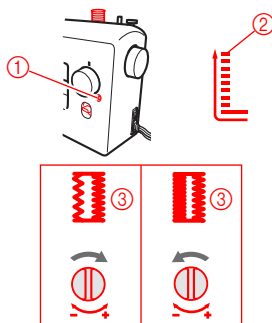

- ① Buttonhole fine-adjustment screw
- ② Left side
- ③ Buttonhole appearance

If the left side is too open, turn the buttonhole fine-adjustment screw with a large screwdriver in the “-” direction.  
If the left side is too tight, turn the buttonhole fine-adjustment screw with a large screwdriver in the “+” direction.

- This adjustment ensures both sides of the buttonhole are the same.

# 5 USING ATTACHMENTS AND APPLICATIONS

## CAUTION

- Always turn off the machine before replacing the presser foot. Otherwise, injuries may occur if the foot controller is accidentally pressed and the machine starts sewing.

### Zipper insertion

Stitch Name	Pattern	Stitch Length [mm (inch)]	Foot
Straight Stitch (Center Needle Position)	9   	3 (1/8)	Zipper Foot "I"

You can use the zipper foot "I" to sew different types of zippers, and can easily position it to the right or left side of the needle.

When sewing with the zipper on the right side, attach the shank to the left pin of the zipper foot. When sewing with the zipper on the left side, attach the shank to the right pin of the zipper foot.

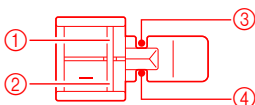

- Right pin for sewing with the zipper on the left side
- Left pin for sewing with the zipper on the right side
- Needle drop point for sewing with the zipper on the left side
- Needle drop point for sewing with the zipper on the right side

### 1 Prepare the fabric with the zipper basted on the wrong side.

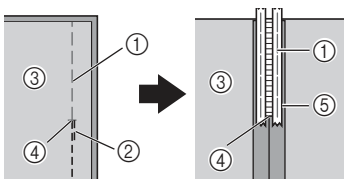

- Basting stitching
- Reverse stitches
- Wrong side of fabric
- End of zipper opening
- Zipper

### 2 Turn off the machine. Attach the zipper foot "I".

## CAUTION

- Turn the handwheel toward you (counterclockwise) and check that the needle does not touch the zipper foot before you start sewing. Choosing a different stitch will cause the needle to hit the presser foot and break, and you may be injured.

### 3 Turn on the machine.

## CAUTION

- Do not turn on the machine while pressing down the foot controller. The machine may start unexpectedly and cause personal injury or damage to the machine.

### 4 With the right side of the fabric facing up, continue sewing with the zipper on the right side of the presser foot.

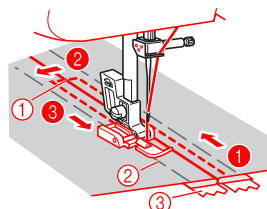

- End of zipper opening
- Basting stitching
- Zipper



- Sew the stitching in order, from 1 to 3.

## CAUTION

- Make sure the needle does not hit the zipper during sewing. If the needle hits the zipper, the needle may break and you may be injured.

- 5 When you have finished sewing, remove the basting stitching.



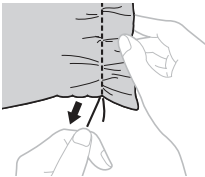

## Gathering

Stitch Name	Pattern	Stitch Length [mm (inch)]
Straight Stitch (Center Needle Position)	9 	3 (1/8)
Straight Stitch (Left Needle Position)	11 	2.5 (3/32)

- 1 Loosen the tension of the upper thread so that the lower thread lies on the underside of the material.
- 2 Sew a single row (or many rows) of straight stitches.
- 3 Pull the lower threads to gather the material.



## Appliqués

Stitch Name	Pattern	Stitch Length [mm (inch)]	Stitch Width [mm (inch)]
Zigzag Stitch	2 	0.7 (1/32)	1.8 (1/8)
Zigzag Stitch	3 	1.5 (1/16)	3.3 (3/16)
Zigzag Stitch	4 	2 (1/16)	5 (3/16)
Zigzag (Satin) Stitch	5 	0.5 (1/32)	5 (3/16)

You can create an appliqué by cutting a different piece of fabric into a shape and applying it as a decoration.

- 1 Baste the cut design to the fabric.



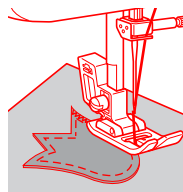

- 2 Carefully sew around the edge of the design with a zigzag stitch.



5

## USING OPTIONAL ACCESSORIES

### Sewing buttons

Stitch Name	Pattern	Stitch Length [mm (inch)]	Stitch Width [mm (inch)]	Foot	Other
Zigzag Stitch	2 	0.7 (1/32)	1.8 (1/8)	Button Sewing Foot "M"	Darning Plate
Zigzag Stitch	3 	1.5 (1/16)	3.3 (3/16)	Button Sewing Foot "M"	Darning Plate
Zigzag Stitch	4 	2 (1/16)	5 (3/16)	Button Sewing Foot "M"	Darning Plate

- 1 Measure the distance between the buttonholes and set the pattern selection dial to the Zigzag Stitch with the desired width.

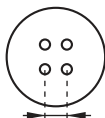

- 2 Turn off the machine.
- 3 Change the foot to the button sewing foot "M".
- 4 Place the darning plate on the needle plate.

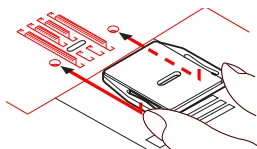

- 5 Turn on the machine.

### CAUTION

- Do not turn on the machine while pressing down the foot controller. The machine may start unexpectedly and cause personal injury or damage to the machine.

- 6 Put a button between the foot and the fabric and make sure that the needle enters the holes without hitting the button. If it hits, see step 1.

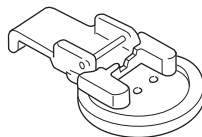

- 7 At a slow speed, sew about 10 stitches.

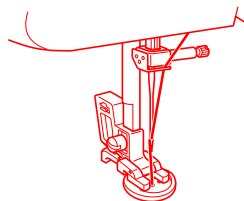

### CAUTION

- Make sure the needle does not hit the button during sewing. The needle may break and you may be injured.

- 8 Pull the upper thread at the end of the stitching to the wrong side of the fabric, and then tie it with the bobbin thread.
  - Use scissors to cut the upper thread and the bobbin thread at the beginning of the stitching.

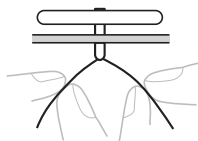

## Darning

Stitch Name	Pattern	Stitch Length [mm (inch)]	Other
Straight Stitch (Center Needle Position)	6	1.6 (1/16)	Darning Plate
Straight Stitch (Center Needle Position)	7	1.8 (1/8)	Darning Plate
Straight Stitch (Center Needle Position)	8	2 (1/16)	Darning Plate
Straight Stitch (Center Needle Position)	9	3 (1/8)	Darning Plate
Straight Stitch (Center Needle Position)	10	4 (3/16)	Darning Plate
Straight Stitch (Left Needle Position)	11	2.5 (3/32)	Darning Plate

- 1 Turn off the machine. Place the darning plate on the needle plate, then turn on the machine.

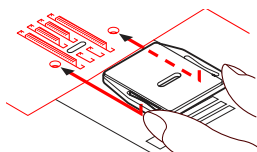

- 2 Either remove both the presser foot and presser foot holder assembly and then lower the presser foot lever.
- 3 Put the section you want to darn under the presser foot together with fabric for reinforcement.
- 4 Turn on the machine.

### CAUTION

- Do not turn on the machine while pressing down the foot controller. The machine may start unexpectedly and cause personal injury or damage to the machine.

- 5 Begin sewing by alternating between gently drawing the work away from you and pulling it toward you.



### Note

- Sew while holding the fabric stretched in order to keep the fabric held down.

- 6 Repeat this motion until the section being darned is filled with parallel lines of stitching.

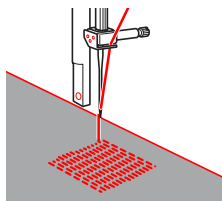

## Using the blind stitch foot

Stitch Name	Pattern	Stitch Length [mm (inch)]	Stitch Width [mm (inch)]
Zigzag Stitch		0.7 (1/32)	1.8 (1/8)
Zigzag Stitch		1.5 (1/16)	3.3 (3/16)
Zigzag Stitch		2 (1/16)	5 (3/16)
Straight Stitch (Center Needle Position)		3 (1/8)	—
Blind Hem Stitch		2 (1/16)	5 (3/16)
Stretch Blind Hem Stitch		2 (1/16)	5 (3/16)

This foot comes in handy not only for stretch blind hem stitching, but also for sewing fabric edges and seams.

### ■ When edge stitching

- 1 Turn off the machine.
- 2 Attach the blind stitch foot. Turn on the machine.

## ⚠ CAUTION

- Do not turn on the machine while pressing down the foot controller. The machine may start unexpectedly and cause personal injury or damage to the machine.

- 3 Position the needle the distance you want the stitch to be from the edge of the fabric, and then lower the needle in that position.
- 4 Turn the foot guide screw and carefully adjust to guide the fabric.

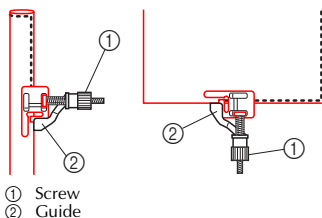

### ■ When sewing seams

- 1 Turn off the machine.
- 2 Attach the blind stitch foot. Turn on the machine.

## ⚠ CAUTION

- Do not turn on the machine while pressing down the foot controller. The machine may start unexpectedly and cause personal injury or damage to the machine.

- 3 Set the pattern selection dial to the Straight Stitch (Center Needle Position). Align the foot guide with the needle position.
- 4 Set the pattern selection dial to the Zigzag Stitch with the desired width.
- 5 Place the fabric under the foot so the foot guide is aligned between both edges of the fabric.
- 6 Lower the presser foot and start sewing.

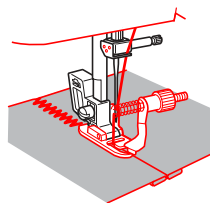

### ■ When stretch blind hem stitching

When stretch blind hem stitching using the blind stitch foot, turn the screw to adjust the guide to the folded hem.

- For more details on blind hem stitching, see page 30.

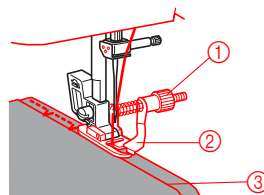

- 1 Screw  
2 Guide  
3 Folded hem



## 6 APPENDIX

### MAINTENANCE

#### Restrictions on oiling

In order to prevent damaging this machine, it must not be oiled by the user.

This machine was manufactured with the necessary amount of oil applied to ensure correct operation, making periodic oiling unnecessary.

If problems occur, such as difficulty turning the handwheel or an unusual noise, immediately stop using the machine, and contact your authorized Brother Service Center or the nearest authorized Brother Service Center.

#### Precautions on storing the machine

Do not store the machine in any of the locations described below, otherwise damage to the machine may result, for example, rust caused by condensation.

- Exposed to extremely high temperatures
- Exposed to extremely low temperatures
- Exposed to extreme temperature changes
- Exposed to high humidity or steam
- Near a flame, heater or air conditioner
- Outdoors or exposed to direct sunlight
- Exposed to extremely dusty or oily environments

#### Note

- In order to extend the life of this machine, periodically turn it on and use it. Storing this machine for an extended period of time without using it may reduce its efficiency.

#### Cleaning

#### CAUTION

- Make sure you unplug the machine before you clean it, otherwise you risk getting an electric shock or being injured.

- 1 Turn off the machine and unplug it.
- 2 Raise the needle and the presser foot.
- 3 Loosen the presser foot screw and the needle clamp screw to remove the presser foot holder and the needle.

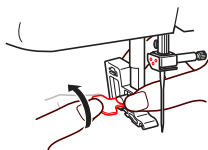

- 4 Using the screwdriver, remove the two screws. Lift up the needle plate as shown in the illustration, and then slide the needle plate to the left to remove it.

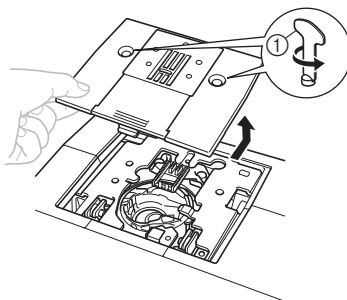

① Use the screwdriver

- 5 Grasp the bobbin case, and then lift it out to the left.

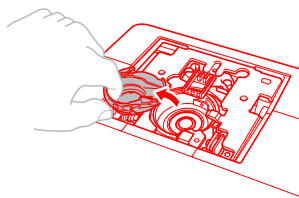

- 6** Use the cleaning brush or a vacuum cleaner to remove any dust from the bobbin race and its surrounding area.

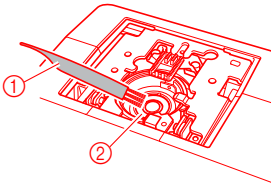

- ① Cleaning brush  
② Race

- Do not apply oil to the bobbin case.

- 7** Insert the bobbin case so that the ▲ mark on the bobbin case aligns with the ● mark on machine as shown below.

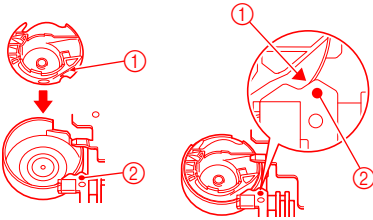

- Align the ▲ and ● marks.

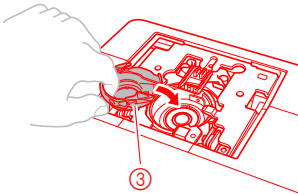

- ① ▲ mark  
② ● mark  
③ Bobbin case

- Make sure that the indicated points are aligned before installing the bobbin case.

- 8** Install the needle plate, and then tighten the screws.

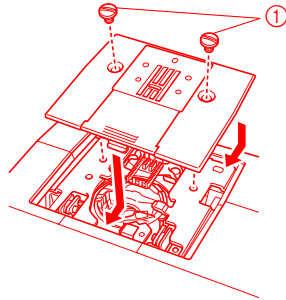

- ① Screws

- Make sure that you install the needle plate securely.

### ! CAUTION

- Never use a bobbin case that is scratched; otherwise the upper thread may become tangled, the needle may break, or sewing performance may suffer. For a new bobbin case (part code: XE9326-001), contact your nearest authorized Brother Service Center.
- Make sure that you fit the bobbin case properly, otherwise the needle may break.

## TROUBLESHOOTING

If the machine stops operating correctly, check the following possible problems before requesting service. You can solve most problems by yourself. If you need additional help, the Brother Solutions Center offers the latest FAQs and troubleshooting tips. Visit us at “<http://support.brother.com>”. If the problem persists, contact your Brother dealer or the nearest authorized Brother Service Center.

Symptom	Possible cause	How to put it right	Page
<b>The sewing machine does not work.</b>	The main power switch is turned off.	Turn on the main power switch.	8
	The bobbin-winder shaft is pushed to the right.	Move the bobbin-winder shaft to the left.	14
	You have not used the foot controller properly.	Use the foot controller properly.	8
<b>Fabric being sewn with the machine cannot be removed.</b>	Thread is tangled below the needle plate.	Lift up the fabric and cut the threads below it, and clean the race.	40
<b>The needle breaks.</b>	The needle is incorrectly installed.	Correctly install the needle.	8
	The needle clamp screw is loose.	Use the screwdriver to firmly tighten the screw.	9
	The needle is bent or blunt.	Replace the needle.	8
	The upper thread was not threaded correctly.	Correct the upper threading.	17
	You have not used the right combination of fabric, thread and needle.	Choose a thread and needle that are appropriate for the type of fabric.	22
	The presser foot you are using is not appropriate for the type of stitch that you want to sew.	Attach the presser foot that is correct for the type of stitch that you want to sew.	–
	The upper thread tension is too tight.	Loosen the upper thread tension.	27
	You are pulling the fabric too much.	Lightly guide the fabric.	–
	You have not fitted the spool properly.	Fit the spool properly.	17
	The area around the hole in the needle plate or the presser foot is scratched.	Replace the needle plate. Contact your retailer or the nearest authorized Brother Service Center.	–
	The bobbin case is scratched.	Replace the bobbin case. Contact your retailer or the nearest authorized Brother Service Center.	–
You have not used a bobbin that has been designed for this machine.	Use a bobbin that has been designed for this machine.	13	
<b>The upper thread breaks.</b>	You have not threaded the upper thread properly. (For example, you have not fitted the spool properly, or the thread has come out of the guide above the needle.)	Correct the upper threading.	17
	There are knots or tangles in the thread.	Remove any knots or tangles.	–
	The needle is not appropriate for the thread you are using.	Choose a needle that is appropriate for the type of stitch.	22
	▼ The upper thread tension is too tight.	Loosen the upper thread tension.	27

Symptom	Possible cause	How to put it right	Page
<b>▲</b>  <b>The upper thread breaks.</b>	The needle is bent or blunt.	Replace the needle.	8
	The needle is incorrectly installed.	Correctly install the needle.	8
	The area around the hole in the needle plate or the presser foot is scratched.	Replace the needle plate. Contact your retailer or the nearest authorized Brother Service Center.	–
	The bobbin case is scratched, or has a burr on it.	Replace the bobbin case. Contact your retailer or the nearest authorized Brother Service Center.	–
	You have not used a bobbin that has been designed for this machine.	Use a bobbin that has been designed for this machine.	13
<b>The lower thread is tangled or breaks.</b>	You have not wound the bobbin thread properly.	Wind the bobbin thread properly.	13
	The bobbin is scratched or does not turn smoothly.	Replace the bobbin.	–
	The thread is tangled.	Remove the tangled thread and clean the race.	40
	You have not used a bobbin that has been designed for this machine.	Use a bobbin that has been designed for this machine.	13
	Bobbin is set incorrectly.	Reset the bobbin thread correctly.	15
<b>▲</b>  <b>The thread tension is incorrect.</b>	You have not threaded the upper thread properly.	Correct the upper threading.	17
	You have not wound the bobbin thread properly.	Wind the bobbin thread properly.	13
	You have not threaded the right combination of thread and needle for the fabric you are using.	Choose a thread and needle that are appropriate for the type of fabric.	22
	You have not attached the presser foot holder properly.	Attach the presser foot holder properly.	–
	The thread tension is incorrect.	Adjust the tension of the upper thread.	27
	You have not used a bobbin that has been designed for this machine.	Use a bobbin that has been designed for this machine.	13
	Bobbin is set incorrectly.	Reset the bobbin thread correctly.	15
<b>The fabric is wrinkled.</b>	You have not threaded the upper thread properly or fitted the bobbin properly.	Thread the upper thread and wind the bobbin thread properly.	13-21
	You have not fitted the spool properly.	Fit the spool properly.	17
	You have not used the right combination of fabric, thread and needle.	Choose a thread and needle that are appropriate for the type of fabric.	22
	The needle is bent or blunt.	Replace the needle.	8
	If thin fabrics are being sewn, the fabric is not being fed correctly.	Sew with stabilizer material under the fabric.	25
	The presser foot you are using is not appropriate for the type of stitch that you want to sew.	Attach the presser foot that is correct for the type of stitch that you want to sew.	35
	The thread tension is incorrect.	Adjust the tension of the upper thread.	27

Symptom	Possible cause	How to put it right	Page
<b>Stitches are skipped.</b>	You have not threaded the upper thread properly.	Correct the upper threading.	17
	You have not used the right combination of fabric, thread and needle.	Choose a thread and needle that are appropriate for the type of fabric.	22
	The needle is bent or blunt.	Replace the needle.	8
	The needle is incorrectly installed.	Correctly install the needle.	8
	Dust has accumulated under the needle plate or in the bobbin case.	Remove the needle plate and clean the plate and the bobbin case.	40
<b>The needle threader can not be used.</b>	The needle has not been raised to the correct position.	Raise the needle by turning the handwheel toward you (counterclockwise) so that the mark on the wheel points up.	19
	You have not inserted the needle properly.	Insert the needle properly.	8
<b>The stitch is not sewn correctly.</b>	The presser foot that you are using is not correct for the type of stitch.	Attach the presser foot that is correct for the type of stitch that you want to sew.	–
	The thread tension is incorrect.	Adjust the tension of the upper thread.	27
	The thread is tangled.	Remove the tangled thread. If the thread is tangled in the bobbin case, clean the bobbin case.	40
<b>The fabric does not feed.</b>	The darning plate is fitted on the needle plate.	Remove the darning plate.	–
	You have not used the right combination of fabric, thread and needle.	Choose a thread and needle that are appropriate for the type of fabric.	22
	The thread is tangled, for example, in the race.	Remove the tangle thread. If the thread is tangled in the race, clean the race.	40
	The presser foot you are using is not appropriate for the type of stitch that you want to sew.	Attach the presser foot that is correct for the type of stitch that you want to sew.	35

## INDEX

- Numerics**  
4-Step Automatic Buttonhole ..... 33
- A**  
Accessories ..... 5  
  optional ..... 5, 37  
Appliqués ..... 36
- B**  
Blind hem stitching ..... 30  
Blind stitch foot ..... 39  
Bobbin winding ..... 13  
Button sewing ..... 37  
Buttonhole  
  adjusting ..... 34  
  making ..... 33  
Buttonhole fine-adjustment screw ..... 34
- C**  
Cleaning ..... 40  
Connecting plugs ..... 7
- D**  
Darning ..... 38  
Darning plate ..... 37, 38  
Double action stitching ..... 32  
Drawing up the lower thread ..... 21
- E**  
Elastic stitching ..... 31
- F**  
Fabric, thread, and needle combinations ..... 22  
Flat bed attachment ..... 6  
Foot controller ..... 8  
Free-arm style ..... 25
- G**  
Gathering ..... 36
- H**  
Handwheel ..... 17
- L**  
Light switch ..... 8  
Lower threading ..... 15
- M**  
Main parts ..... 6  
Main power ..... 8  
Maintenance ..... 40
- N**  
Needle  
  checking ..... 8  
  combinations with fabric and thread ..... 22  
  replacing ..... 8  
Needle threader ..... 19
- O**  
Overedge stitching ..... 31
- P**  
Pattern selection dial ..... 11  
Patterns ..... 11  
Presser foot changing ..... 10
- Q**  
Quick-set bobbin ..... 16, 21
- R**  
Race cleaning ..... 40  
Reverse sewing lever ..... 12
- S**  
Spool pin ..... 13, 17  
Stitches  
  built-in ..... 29  
  names ..... 11  
Straight stitching ..... 29
- T**  
Thread cutter ..... 24  
Thread tension ..... 27  
Threading  
  lower ..... 15, 16  
  upper ..... 17  
Troubleshooting ..... 42  
Twin needle  
  attaching ..... 9, 25  
  sewing ..... 25
- U**  
Upper tension control dial ..... 27  
Upper threading ..... 17
- Z**  
Zigzag stitching ..... 29  
Zipper insertion ..... 35

Please visit us at <http://support.brother.com> where you can get product support and answers to frequently asked questions (FAQs).